

LSR 3B

Throughbeam photoelectric sensors

en 04-2016/01 50108961

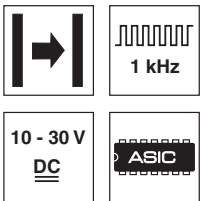

0 ... 10m

- Throughbeam photoelectric sensor with visible red light
- High performance reserve
- Small and compact construction with robust plastic housing, protection class IP 67 for industrial application
- Fast alignment through *brightVision*®
- Push-pull switching outputs
- High switching frequency for detection of fast events
- Warning output for increased availability
- Activation input

Dimensioned drawing

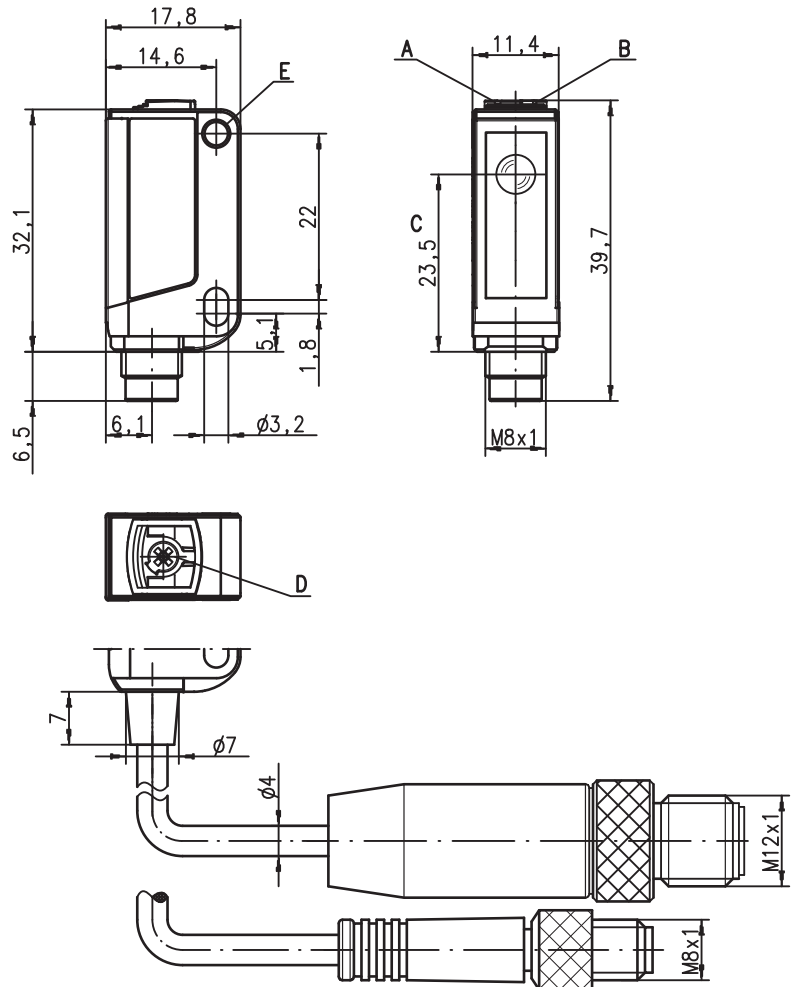

- A Green indicator diode
- B Yellow indicator diode
- C Optical axis
- D Potentiometer for operating range adjustment (LSR 3B/66.1... only)
- E Attachment sleeve

Electrical connection

Plug connection, 4-pin

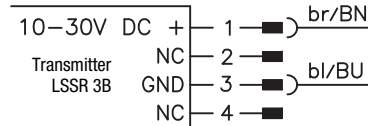

Cable, 4-wire

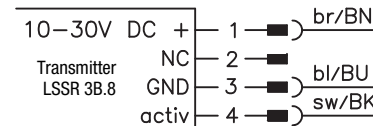
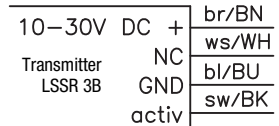

Plug connection, 4-pin

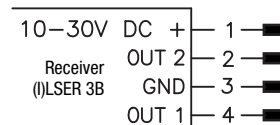

Cable, 4-wire

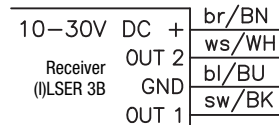

Accessories:

(available separately)

- Mounting systems (BT 3...)
- Cable with M8 connector (K-D ...)
- Reflectors
- Reflective tapes

We reserve the right to make changes • DS_LSR3B_en_50108961.fm



Specifications

Optical data

Typ. operating range limit ¹⁾	0 ... 10m
Operating range ²⁾	0.05 ... 8.5m
Light source ³⁾	LED (modulated light)
Wavelength	620nm (visible red light)

Timing

Switching frequency	1,000Hz (see order guide)
Response time	0.5ms
Delay before start-up	≤ 300ms

Electrical data

Operating voltage U_B ⁴⁾	10 ... 30VDC (incl. residual ripple)
Residual ripple	≤ 15% of U_B
Open-circuit current	≤ 14mA (per sensor)
Switching output	.../66 ⁵⁾ 2 push-pull switching outputs pin 2: PNP dark switching, NPN light switching pin 4: PNP light switching, NPN dark switching .../6 ⁵⁾ 1 push-pull switching output pin 4: PNP light switching, NPN dark switching light/dark switching
Function characteristics	permanently set or adjustable, see order guide
Signal voltage high/low	$\geq (U_B - 2V) / \leq 2V$
Output current	max. 100mA
Operating range	

Indicators

Green LED	ready
Yellow LED	light path free
Yellow LED, flashing	light path free, no performance reserve

Mechanical data

Housing ⁶⁾	plastic (PC-ABS); 1 attachment sleeve, nickel-plated steel
Optics cover	plastic (PMMA)
Weight	with connector: 10g with 200mm cable and connector: 20g with 2m cable: 50g
Connection type	2m/5m cable (cross section 4x0.20mm ²), connector M8 metal, 0.2m cable with connector M8

Environmental data

Ambient temp. (operation/storage)	-30°C ... +55°C / -30°C ... +70°C
Protective circuit ⁷⁾	2, 3
VDE safety class	III
Protection class	IP 67
Light source	free group (in accordance with EN 62471)
Standards applied	IEC 60947-5-2
Certifications	UL 508, CSA C22.2 No.14-13 ^{4) 8)}

Options

Warning output autoControl warn	PNP transistor, counting principle
Signal voltage high/low	$\geq (U_B - 2V) / \leq 2V$
Output current	max. 100mA
Activation input active	
Transmitter active/not active	$\geq 8V / \leq 2V$
Activation/disable delay	≤ 1ms
Input resistance	10KΩ ± 10%

- 1) Typ. operating range limit: max. attainable range without performance reserve
- 2) Operating range: recommended range with performance reserve
- 3) Average life expectancy 100,000h at an ambient temperature of 25°C
- 4) For UL applications: for use in class 2 circuits according to NEC only
- 5) The push-pull switching outputs must not be connected in parallel
- 6) Patent Pending Publ. No. US 7,476,848 B2
- 7) 2=polarity reversal protection, 3=short-circuit protection for all transistor outputs
- 8) These proximity switches shall be used with UL Listed Cable assemblies rated 30V, 0.5A min, in the field installation, or equivalent (categories: CYJV/CYJV7 or PVVA/PVVA7)

Remarks

Operate in accordance with intended use!

- ⚠ This product is not a safety sensor and is not intended as personnel protection.
- ⚠ The product may only be put into operation by competent persons.
- ⚠ Only use the product in accordance with the intended use.

UL REQUIREMENTS

Enclosure Type Rating: Type 1

For Use in NFPA 79 Applications only.

Adapters providing field wiring means are available from the manufacturer. Refer to manufacturers information.

CAUTION – the use of controls or adjustments or performance of procedures other than those specified herein may result in hazardous radiation exposure.

ATTENTION! Si d'autres dispositifs d'alignement que ceux préconisés ici sont utilisés ou s'il est procédé autrement qu'indiqué, cela peut entraîner une exposition à des rayonnements et un danger pour les personnes.

Tables

0	8,5	10
---	-----	----

	Operating range [m]
	Typ. operating range limit [m]

Diagrams

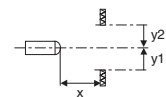
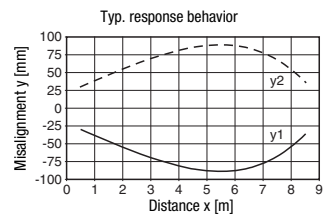

Remarks

A light axis consists of a transmitter and a receiver with the following designations:

- []LSR = Complete light axis
- LSSR = Transmitter
- []LSER = Receiver

Mounting system:



- ① = BT 3 (part no. 50060511)
- ②+③ = BT 3.1 ¹⁾ (part no. 50105585)
- ①+②+③ = BT 3B (part no. 50105546)

1) Packaging unit: PU = 10 pcs.

LSR 3B

Throughbeam photoelectric sensors

Order guide

Selection table		Order code →											
Equipment ↓		LSR 3B/66-S8 Part no. 50108508 (Tr) Part no. 50108514 (Re) LSR 3B/66.8-S8 Part no. 50108509 (Tr) Part no. 50108514 (Re) LSR 3B/66.1-S8 Part no. 50108508 (Tr) Part no. 50108515 (Re) LSR 3B/66.8 Part no. 50108510 (Tr) Part no. 50108516 (Re) ILSR 3B/4-S8 Part no. 50108508 (Tr) Part no. 50108517 (Re) ILSR 3B/4.8.200-S8 Part no. 50108512 (Tr) Part no. 50108518 (Re) LSR 3B/66.8.5000 Part no. 50108511 (Tr) Part no. 50108519 (Re) LSR 3B/66.8.200-S12 Part no. 50111441 (Tr) Part no. 50111442 (Re) LSR 3B/66.200-S12 Part no. 50111440 (Tr) Part no. 50111442 (Re)											
Output 1 (OUT 1)	push-pull switching output	light switching	○	●	●	●	●				●	●	●
		dark switching	●										
	PNP transistor output	light switching	○					●	●				
		dark switching	●										
	NPN transistor output	light switching	○										
		dark switching	●										
Output 2 (OUT 2)	push-pull switching output	light switching	○	●	●	●	●				●	●	●
		dark switching	●										
	PNP transistor output	light switching	○										
		dark switching	●										
	NPN transistor output	light switching	○										
		dark switching	●										
warning output (PNP transistor)	light switching	○						●	●				
Connection	cable 2,000 mm	4-wire					●						
	M8 connector, metal	3-pin											
	M8 connector, metal	4-pin	●	●	●		●						
	M8 connector, metal, snap-on	4-pin											
	200 mm cable with M8 connector	3-pin											
	200 mm cable with M8 connector	4-pin							●				
	200 mm cable with M12 connector	4-pin									●	●	
cable 5,000 mm	4-wire												
Configuration	permanently set to maximum range		●	●		●	●	●	●	●	●	●	
	potentiometer, rotational angle approx. 250°				●								
Features	activation input			●		●		●	●	●	●		



- Adapter plate: BT 3.2 (part no. 50103844) for alternate mounting on 25.4 mm hole spacing (Omron E3Z, Sick W100...)

